

Open Channel Flowmeter 713

General

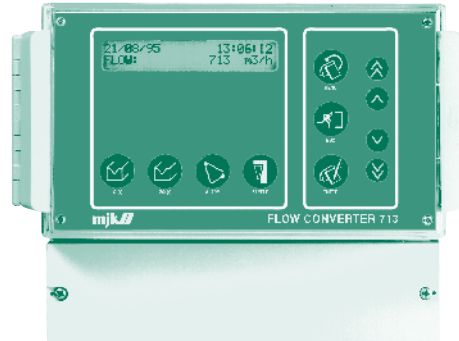

Flow Converter 713 is designed for measuring and recording water flow in open ducts and channels. Flow Converter 713 is a complete instrument for the measuring of instantaneous flow and recording of totalised water flow. It can be adapted to any type of weir or flume.



Special features

- Supplied with either ultrasonic or hydrostatic sensor.
- Maximum accuracy with measuring ranges down to 0-10 cm.
- Flow Converter 713 is calibrated from the front panel.
- Easy to operate with setup information in English or other user-specified language.
- Security access code can be programmed.
- Adaption to any kind of weir or flume.
- Built-in control of Sampler e.g. MJK 780.
- Built-in totalizer with counter.
- All values stored in an E²-prom.
- Indication of average flow (m³/hour) actual, the last hour, today, the last 24 hours.
- Indication of accumulated flow (m³) actual, the last hour, today, the last day.
- If 713 is set as an emergency stormflow meter, the number of stormflows, stormflow time and volume and start and stop time for the last stormflow are counted.
- Alarm can be set for high and low flow, and excess of 1- and 24-hour volumes.

Application

The Flow Converter 713 is especially used for measurement and recording of flow in public and industrial sewage plants. It is also installed in pumping stations for recording of emergency stormflow and for measuring in fish farming, in channels for irrigation system and for measurement in streams and rivers.

Function

The sensor of the Flow Converter provides a signal proportional to the level. The amplifier linearizes the signal from the sensor so it is proportional with the flow rate.

The Flow Converter 713 can calculate flow on the basis of one of the three following principles:

- Preprogrammed formulas for different dimensions of the most common flumes and weirs such as Parshall-Venturi flumes and V-notch weirs based on ISO 1438.
- When using non-standard flumes or weirs the calculation formula can be programmed.
- For flumes where no calculation formula exists, a number of known flow values can be entered, on the basis of these a point-linearization is made. This is used for flumes which do not follow the ISO 1438 standard.

Specifications

Ultrasonic Sensor

Measuring range	0-1 m ; 0-3 m
Frequency	125 kHz ; 30 kHz
Spreading	6 ° ; 3 °
Temperature	-20...+60 °C
Blocking distance	40 cm ; 75 cm
Dimension	Ø 103 × 94 mm
Materials	PP Green/Glass filled polyester Black/Glass reinforced epoxy White
Cable	Shielded, oil resistant PVC insulation, length 12 metres.
Can be extended to	Max. 50 m with 690010 cable ; Max. 100 m with 690010 cable
Housing	IP 68, water proof, withstands immersion, max. 1 bar
CE	EN50081-1, EN50082-1

Pressure Transmitter Expert™ 3400

Measuring ranges	203961 Expert™ 3400, range 0 - 0.3 m 1" RG top 203962 Expert™ 3400, range 0 - 1 m 1" RG top 203963 Expert™ 3400, range 0 - 3 m 1" RG top
Temperature range	-10 ... +50 °C
Temp. drift	Better than ± 0,01% / °C
Measurement accuracy	Better than ± 0,1% FS @10 - 30 °C / ± 0,2% FS @ full temp. range
Long time stability	Better than ± 0,1% FS per year
Dimension	Ø 50 × 167 mm
Supply voltage	10 - 30 V DC (12 - 30 V DC for cable lengths above 110 m)
Output signal	2-wire, 4 - 20 mA (passive transmitter)
Cable	2 × 0,5 mm ² (pressure) + 5 × 0,15 mm ² (data), shielded, PUR insulation
Cable length	12 m. Can be extended max 600 Ω
Enclosure	IP 68, withstands a static pressure equal to max. overpressure.
Approvals	ATEX: II 2G EEx ia IIC T5/T6 and CE: EN61000-6-3/-4:2001, EN61000-6-1/-2:1999, EN50014:1997 E, EN50020:2002

Converter 713

Measuring ranges	0-0,3 m, 0-1 m, 0-3 m
Dimensions	185 × 240 × 115 mm (h × w × d)
Supply	220-240V AC, 110-120V AC or 24V DC appr. 10 VA
Temperature	-20...+60 °C
Materials	House and cover: Polystyrol
Housing	IP 65
Input signal	From ultrasonic sensor, pressure transmitter or 4-20 mA
Digital outputs	Terminals 6-17: relay 1-4, max. 250 V, 4 A resistive load, max. 100 VA inductive load. Can be chosen as alarm, counter, flow>0 or sampler outputs. Terminals 18-20: relay 5 pulse (optocoupler) max 36 V, 50 mA one shot, 100 msec - 10 sec programmable.
Analogue output	Terminals 21-22: 0-20 / 4-20 mA, max. 500 Ω, galvanic isolation.
Serial output	RS 232 prepared
Calculation	Standard formulas according to ISO 1438 Optional formula $Q = C \times h^2$ or point-linearization
Indication	2×24 characters LCD display for readout and programming
Accuracy	≤ ±1 % (min. ±1 mm)
CE	EN50081-1, EN50082-1

Ultrasonic measuring system

Standard connection

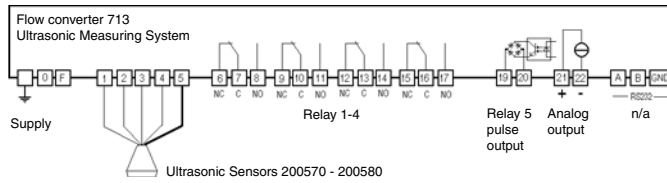

Ultrasonic measuring system using Shuttle Level Transmitter

The level transmitter 511 is applied as preamplifier when the distance between the measuring location and the converter is greater than 50/100 m. It is the resistance (max. 600 Ω) which limit the length with a 3-wire, 4-20 mA supply.

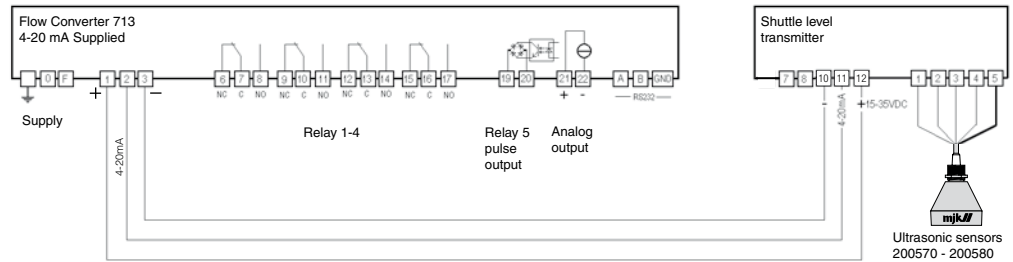

Hydrostatic measuring system

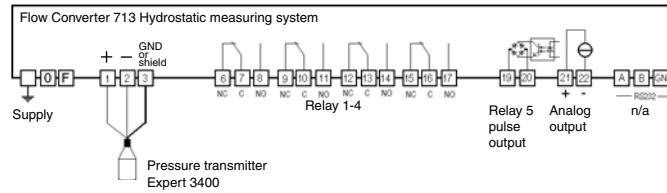

Mounting

Ultrasonic sensor

The ultrasonic sensor is mounted behind the weir at a distance of 3-4 times the head. The ultrasonic sensor has a very narrow spreading of the sound signal and the distance to the highest level to be measured must not be less than the blocking distance and not more than the range + the blocking distance.

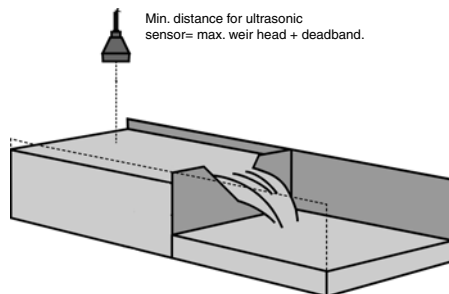

Hydrostatic sensor

The pressure transmitter is mounted behind the weir at a distance of 3-4 times the head or in a stilling well, to the flume. The pressure transmitter has as standard a 1" thread for mounting on a pipe.

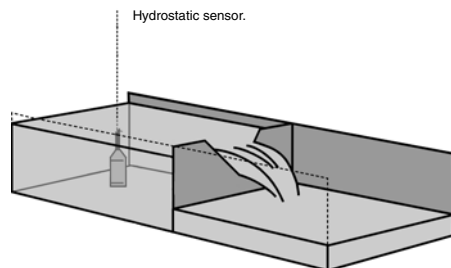

Dimensions

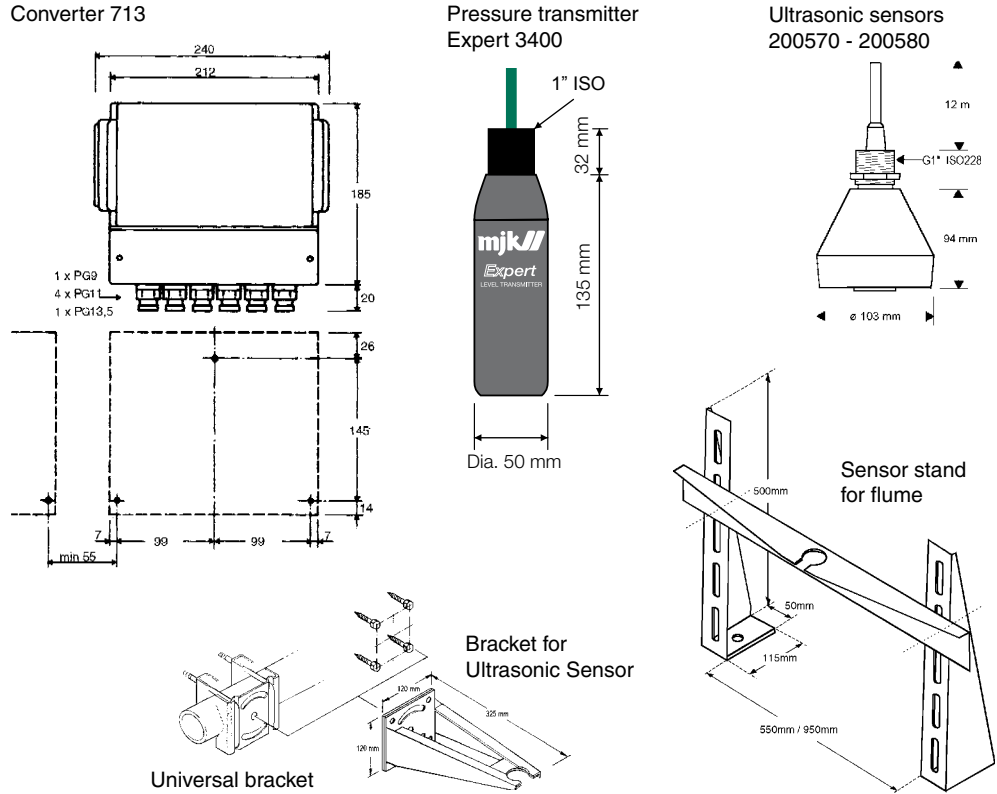

Order numbers

Open Channel Flowmeter 713

201455	713U-1121, ultrasonic meas. system, incl. 200580, meas. range 0-1 m
201460	713U-1131, ultrasonic meas. system, incl. 200570, meas. range 0-3 m
202600	713P-1104, without sensor, 4-20 mA supplied
201464	713 - system complete with Shuttle Level Transmitter (202600 + 201215)
202650	713P-1114, hydrostatic meas. system, incl. 203961, meas. range 0-0,3 m
202655	713P-1124, hydrostatic meas. system, incl. 203962, meas. range 0-1 m
202660	713P-1114, hydrostatic meas. system, incl. 203963, meas. range 0-3 m

Accessories for Open Channel Flowmeter 713

200105	Panel mounting kit
200115	Local mounting kit with rainproof roof
200521	713U, 10 - 30 V DC supplied
200522	713P, 10 - 30 V DC supplied

Accessories for Ultrasonic Sensor

200590	Connection box for cable for Ultrasonic Sensor
200595	Cable lenght not standard (+ cable pr. meter above standard lenght)
690010	Cable for Ultrasonic Sensor (state meter)
200205	Universal bracket
200220	Bracket for Ultrasonic Sensor
200230	Sensorstand for flume for Ultrasonic Sensor, max. flume width 550 mm
200235	Sensorstand for flume for Ultrasonic Sensor, max. flume width 950 mm

Accessories for Pressure Transmitter Expert 3400

202922	Connection box for cable for Pressure Transmitter
202923	Connection box for cable for Pressure Transmitter, with connector for programmes
200126	Display insert 531 for connection box
202920	Cable lenght not standard (+ cable pr. meter above standard lenght)
691014	Cable for Pressure Transmitter Expert 3400 (state lenght in metres)

For measurement of water flow in open systems MJK supplies a range of prefabricated flumes. The flumes are manufactured in PVC, glass fibre and stainless steel. The flumes are ready for installation.

- Parshall, Venturi and Palmer & Bowlus flumes are made according to standards.
- The flumes are delivered as complete channel sections ensuring the best possible measuring accuracy.
- Standard types which cover the range from 25 m³/h to 2000 m³/h.
- Easy fitting and mounting.

For more information about the MJK programme of flumes, see data sheet 3.8.

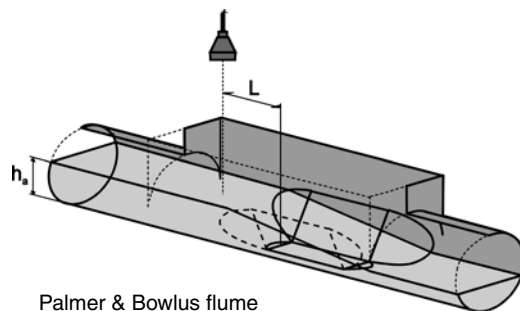
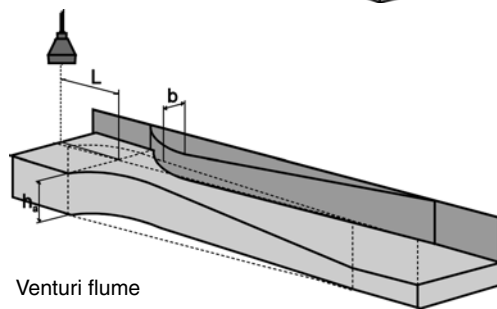
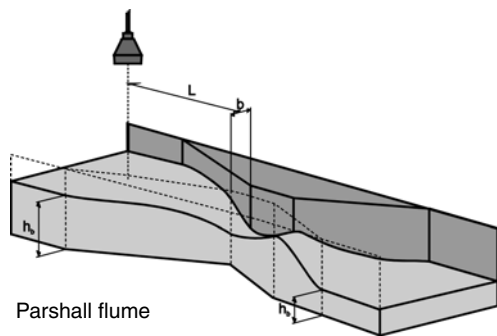
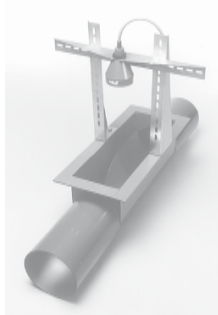

The Flow converter 713 is used for measuring the flow in open flumes and weirs. The determination of the flow rate is based on the following basic mathematical function:

$$FLOW Q = f(level^x \cdot constant)$$

The exponent x and the constant depends on the dimensions of the weir or the flume. The method of measurement and linearization complies with the norm ISO 1438. The norm indicates how the head over the weir and flumes are constructed and gives the calculations for the linearization.

The Flow converter is operated by means of 4 function keys: the flow key, the summation key, the alarm key and the sample key. See the description of the function keys below.

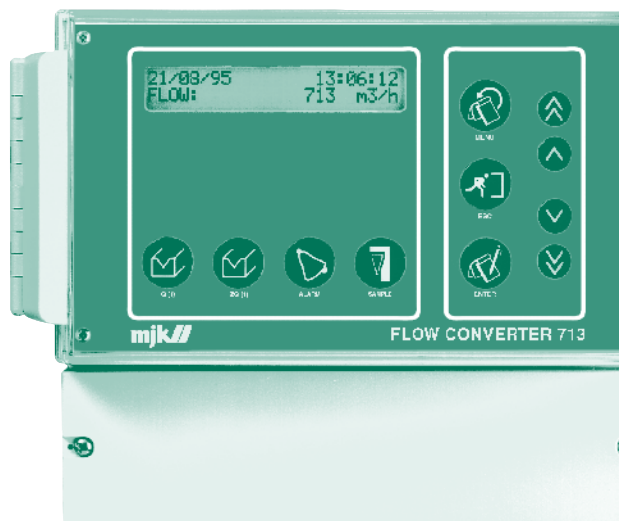

Function key for flow $Q_{(t)}$:

- the instantaneous flow
- average flow for the last hour
- average flow today
- average flow for the last 24 hours

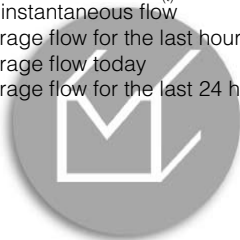

Totalized $\Sigma Q_{(t)}$:

- Flow*
- total flow.
 - total flow for the last hour.
 - total flow today.
 - total flow for the last 24 hours.

Storm flow measurement

- total number of storm flows
- total time of storm flow
- total flow of storm flow.
- amount at last storm flow.
- storm flow start/end

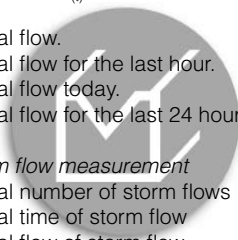

Function key for alarms:

- display of the previous 9 alarms with time for start and end of alarm.
- The flowmeter has alarms for: sensor errors (internal monitoring of flow converter), high and low flow alarm, high hour flow, high day flow.

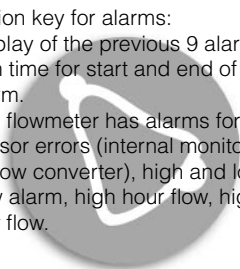

Function key for sampler:

- total number of samples
- total number of samples today
- total number of samples for the last 24 hours.



The flow meter has outputs for transmission of measuring and counting values for connection to printer or data transmitter.

Distributed by:

MJK offices:

Denmark
www.mjk.dk
mjk@mjk.dk
+45 45 56 06 56

Norway
www.mjk.no
mjk@mjk.no
+47 69 20 60 70

The Netherlands
www.mjk.com
mjknl@mjk.com
+31 251 672171

Sweden
www.mjk.se
kontoret@mjk.se
+46 53 31 77 50

North America
www.mjk.com
mjkusa@mjk.com
+1 847 482 8655

Australia
www.mjk.com
mjk@mjk.com
+61 3 9755 1529